

FEHLMANN

report

CUTTING-EDGE
TECHNOLOGY
MADE IN
SWITZERLAND
SINCE 1930



VERSA®
High Performance
Machining Centers

FEHLMANN
and vocational
training

Active for
climate and
environment

FEHLMANN close to the customer

Contact with customers and operators at trade fairs and in-house demonstration days provides FEHLMANN with the opportunity to discuss technical ideas and discover our customers' requirements.

This exchange is important in shaping our direction in terms of development and production. Therefore, FEHLMANN is an exhibitor at numerous trade fairs.

After the forced break due to the pandemic, the premiere of the VERSA 945 with ERL and rack magazine for 256 tools was celebrated at EMO Milano 2021. This was followed by the inauguration of the showroom in Isernhagen near Hanover with our in-house demonstration days.

At the Swiss Production Forum in Oerlikon, FEHLMANN presented the VERSA 645 linear milling-grinding center and the new PICOMAX 56 mill to an interested audience. Another highlight was our participation in SIAMS Moutier 2022. At AMB Stuttgart, the VERSA 745 was very well received by visitors.

We were very pleased with the high number of visitors at CIMT Beijing 2023, where FEHLMANN took the opportunity to present its high-quality innovations "made in Switzerland" to the Asian market.

Of course, we were also present at the first live edition of the INNOTEQ in Bern, the meeting point of the Swiss manufacturing industry. Also, FEHLMANN provided no less than nine PICOMAX 21 machines for the Swiss Skills vocational championships in Berne and Delémont.



This year, the SMM Technology Days also took place in Seon. 200 participants attended this event on June 1 and 2, to discover new and interesting innovations in the areas of automation and tool and die making.



FAIRS AND EVENTS CALENDAR

We are already looking forward to your visit at a trade fair. Among other events, the FEHLMANN team will be at EMO Hannover from September 18 – 23, 2023, SIAMS Moutier from April 16 – 19, 2024 and AMB Stuttgart September 10 – 14, 2024. May we welcome you there personally?

Upcoming trade fair and event dates can also be found at www.fehlmann.com



Simply hold your smartphone camera over the code.

Constant innovation



Dear readers

At FEHLMANN, our VERSA machines are becoming increasingly important. More than half of the company's sales are generated by this machine range. In 2008, the VERSA 825 celebrated its premiere, when it was presented to the trade public for the first time at the AMB Stuttgart. In the meantime, it has grown into a complete range of machines: in 2022 it was supplemented by the newest family member, the VERSA 745 and the 3-axis version, VERSA 743. After 15 years, it is now time to replace the 825. We are proud of the fact that our

flagships, currently available in 3 sizes, are proving themselves with our customers on a daily basis. And they do so with the highest accuracy and performance requirements in the areas of milling, drilling and grinding. Read our focus topic in this issue, starting on page 4.

Everyone is talking about the shortage of skilled workers. But doing nothing is not an option: specialist training has become a strategic task, and is a high priority for many companies. No company can survive without well-trained, competent employees. Starting on page 8, we would like to introduce you to our apprentice departments. Do not hesitate to ask us – we would be happy to give you a look at our modern (training) workshops and offices!

PICOMAX 56 mill is another novelty that has been very well received by the market. Specially designed for technical training and prototyping, this machine is perfectly in tune with the times: it is extremely easy to operate and does not shy away from modern production technologies, with high tool speeds and axis feeds.

The innovative control concept of the Heidenhain TNC7 is presented, starting on page 10. The new, convenient and efficient programming environment will be available for FEHLMANN machines starting in 2024.

Another focus topic, energy efficiency, is a significant concern for all of us. But sustainability is not limited to the extremely advanced energy management that has been offered with FEHLMANN machines for many years. The high degree of vertical integration at our site in Seon/Switzerland, which minimizes climate-damaging transports, the ever-improving in-house production methods, as well as the modern production and operating equipment, which is constantly optimized in terms of energy, also make a significant contribution.

I wish you an interesting read and send you my best regards.

Frank Fehlmann, CEO and Chairman of the Board

Table of contents

TECHNOLOGY AND DEVELOPMENT	
VERSA® – The high-end product line of high-performance machining centers	4
VERSA® – The right machine for every workpiece size	6
Automation solutions	6
FEHLMANN rack magazines	7

INSIDE FEHLMANN	
FEHLMANN and vocational training	8
PICOMAX 56 mill /56 L mill	9

TECHNOLOGY AND DEVELOPMENT	
FEHLMANN innovations	10

CUSTOMERS AND WORK	
MIRAD Microwave AG – Highest precision in and for new dimensions	11

SUSTAINABILITY	
Active for climate and environment	12

INSIDE FEHLMANN – OUTLOOK	
A strong team	15

IMPRINT

Publisher:
Fehlmann AG Machine Factory
Birren 1, 5703 Seon / Switzerland
Circulation: 5800 Exemplare
Publication: September 2023
Contact: mail@fehlmann.com,
Tel. +41 62 769 11 11

VERSA® – The high-end product range of high-performance machining centers



VERSA 825/823

Maximum productivity for dynamic and precise 5-axis or 3-axis machining



VERSA 645/643 linear

Highly dynamic and precise 5-axis or 3-axis machining



VERSA 945/943

Maximum accuracy with high dynamics for 5-sided or 5-axis machining of parts up to Ø 650 mm. 3-axis version with fixed table for parts up to 1000 kg



VERSA 745/743

Dynamic and precise 5-sided/5-axis simultaneous machining of parts up to Ø 500 mm. 3-axis version with fixed table for parts up to 800 kg

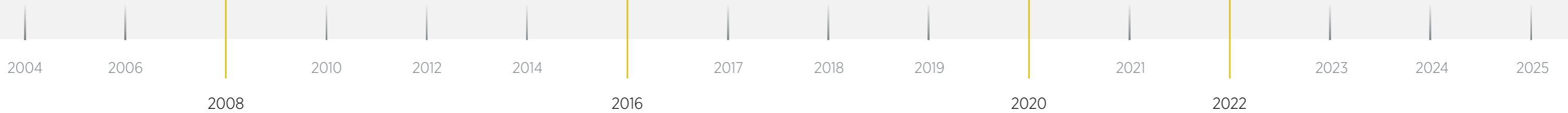

The VERSA line of machining centers in portal design has been established on the market since 2008. In line with customer and market requirements, the high-end product line has been continuously developed by our specialists in Switzerland and today presents itself as a modern, innovative VERSA range, with the following models – VERSA 945/943, VERSA 745/743 and VERSA 645 linear/643 linear.

The pioneer from 2008, the VERSA 823/825, is now bowing out of the VERSA series. The last VERSA 825 was produced this year.





FEHLMANN rack magazines

VERSA® – The right machine for every workpiece size

Productivity and cost efficiency are decisive factors in mechanical production. The VERSA product line meets these requirements in an exemplary

manner. Milling and hard milling, as well as coordinate and contour grinding, can be perfectly combined on VERSA machining centers. Invest once and

use your machine in many ways. The graduated machine sizes ensure that the optimum machine is available for every application.

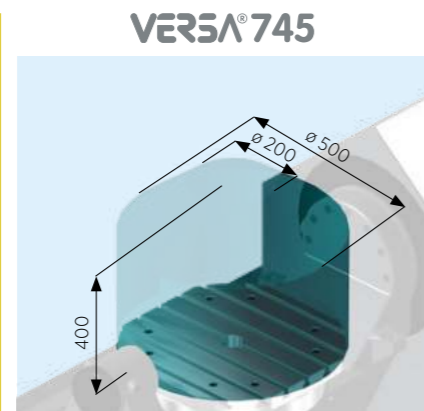

VERSA extended magazines

Higher efficiency, productivity and process reliability

The VERSA machining centers in portal design are convincing due to their maximum accuracy with high dynamics, as well as optimal operability and accessibility. For flexible and efficient production of demanding workpieces, a wide range of tools is also required. In addition to the integrated standard tool



changers, various sizes of rack magazines are available for the VERSA models. Depending on the tool holder and tool dimensions, these are scalable from 112 up to 432 tools (HSK-A63) or from 160 to 600 tools (HSK-E50). The extended magazines are placed on the left side of the machine to save space. They are loaded quickly and easily from the front via an external loading unit.

Automation solutions

Automation solutions for pallet and parts handling significantly increase the productivity of machining centers. Individual parts and small batches can thus be produced automatically without restricting accessibility. It does not matter whether a machine is equipped with automation from the beginning or is retrofitted. Thanks to numerous projects, FEHLMANN has a great deal of experience in this area and will also find the optimal configuration for your application.



VERSA production island 5-axis machining center with rack magazine, articulated arm robot for parts handling and high-bay storage for raw and finished parts



Two VERSA 5-axis machining centers with modular robot system Erowa Robot Dynamic 150L



Two VERSA 5-axis machining centers, each with a rack magazine with a robot-assisted parts handling system



Workpiece robot on five VERSA 5-axis machining centers with rack magazine

FEHLMANN and vocational training

Apprenticeship training – our investment in the future

Well-trained, enterprising skilled workers are the foundation of our economy. We have been committed to training young people for many years and offer them the opportunity for a successful professional future. Every year, we train a total of more than 20 apprentices as polymechanics, automation technicians and commercial clerks.



Apprentices at FEHLMANN – highly motivated and interested



PICOMAX machines have been part of the training standard in countless training workshops and training centers for decades. Since 2022, the Swissmech training center in Landquart in Graubünden has seven state-of-the-art PICOMAX 56 mill machines. www.gr.swissmech.ch

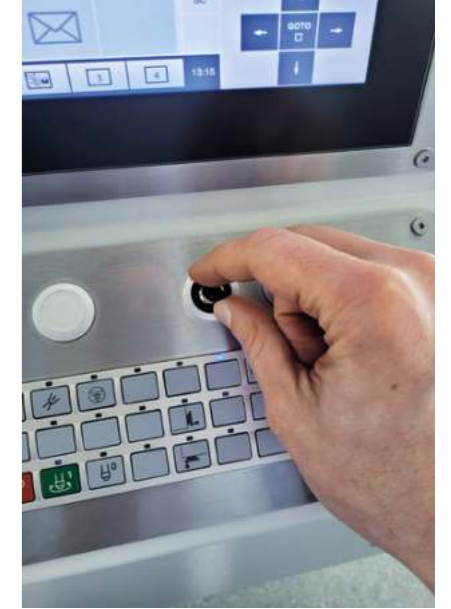

CNC functions are hidden and the display is simplified to show only essential information



Commercial clerk trainees have the opportunity to work in various areas in our company and are supervised and accompanied by experienced trainers



Production technology and automation are the focus of the basic vocational training for automation technicians

Modern, practice-oriented mechanical vocational training

Our long-standing cooperation with the most important national vocational training associations gives us in-depth knowledge about the needs and requirements of modern, sustain-



able vocational training. Thanks to high flexibility, operator ergonomics and modern design, FEHLMANN machines are ideally suited for the practical training of future specialists.

We have responded accordingly to the request for a simple conventional milling machine and have developed the mill version of the PICOMAX 56 especially for this purpose. Conventionally operable and with a simple linear set for switching on a milling feed.

The PICOMAX 56 mill is ideally suited for modern, practice-oriented training – for both conventional and CNC machining.

3-/4-axis milling machine PICOMAX 56 in mill version

The operating concept of the mill version allows rapid and precise milling, drilling and threading of individual parts and small batches.



Around 12 prospective polymechanics complete their training in the FEHLMANN training workshop and learn the mechanical basics directly on our machines

PICOMAX 56 mill / 56 L mill

Powerful also for up-to-date training

From the basics of milling to advanced CNC applications, the mill version of the PICOMAX 56 is ideally suited for modern, hands-on training - for both conventional and CNC machining. With the FEHLMANN mill functions and the three mechanical handwheels, the controls become a simple digital display. Thus, the basic knowledge of conventional milling can be taught up close and, at the same time, with maximum operator protection - thanks to the safety guard.

From beginner to professional mode with the turn of a key

By simply turning the additional CNC / manual key switch, the milling machine can be switched to a purely conventional machine in a flash. Vocational trainers can configure the settings as desired and save these according to the training level. The easy, logical operation, the modern, compact machine concept, the technical features and high flexibility make the combination of manual and CNC milling machine PICOMAX 56 mill the perfect training machine.

Intermediate step from manual to CNC with single block paraxially

The FEHLMANN function “single block paraxially” is activated with the key switch. This function enables positioning with manual input by the Heidenhain TNC 620 control – operation like a linear control.

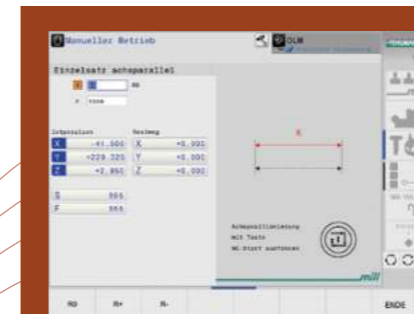

FEHLMANN function “single block paraxially” – operation like a linear control system

PICOMAX 56 and PICOMAX 56 L in TOP or mill version, discover the 3- / 4-axis milling machines for manual and CNC use:



FEHLMANN- Innovations

New control and hardware generation HEIDENHAIN TNC7

As of fall 2023, the new TNC7 control will be optionally available for all FEHLMANN CNC machines. This control offers additional smart functions, as well as the option of graphic programming directly on the touchscreen. The customizable user interface with dark or standard mode is even more ergonomic and enables increased operating efficiency.



NEW

State-of-the-art control technology for maximum productivity – the new HEIDENHAIN TNC7

Calibration of FEHLMANN machines – Quick and easy

For consistent high precision 5-axis milling, regular calibration of FEHLMANN machines is important. Thanks to the FEHLMANN Cycle 333 AUTO-CALIBRATION, this can be done within a few minutes – easily and reliably. The professional calibration ensures consistent high accuracy within the entire machining area.



Consistent high precision 5-axis milling with the FEHLMANN Cycle 333 Auto-Calibration

FEHLMANN motor spindles – The heart of the matter

The FEHLMANN motor spindles – the heart of every FEHLMANN machine – have been developed by us since 1996 and are produced in air-conditioned workshops on state-of-the-art machines.

Thanks to in-house production of key components that determine quality, we are able to respond quickly, cost-effectively and flexibly to further developments such as innovative material technologies and manufacturing processes.

One example: dry machining and trochoidal milling technology with low cutting forces at high speeds have become increasingly popular in recent years. We have adapted our motor spindles accordingly, ensuring that our FEHLMANN customers can also benefit from the advantages of this new manufacturing process. Thus, the new FEHLMANN motor spindles optimally meet high cutting demands and consistently guarantee excellent surfaces and tool life.



Whether strong torque or high speed for HSC milling – FEHLMANN motor spindles are up to all tasks

Highest precision in and for new dimensions

The company MIRAD Microwave AG in Wittenbach is engaged in the development and production of components for satellite communication. In connection with the opening up of a new frequency band at 60 GHz, the company purchased a VERSA 645 linear 5-axis machining center from Fehlmann AG. With the development of new components and subsequent qualification tests, MIRAD has now demonstrated that a final contour accuracy of 0.5 microns or even better has become a reality.

Pictures and text: Tony Blättler, Managing Director MIRAD Microwave AG, and Manfred Lerch, Editorial Office Lerch

MIRAD specializes in antenna systems for satellite communications. The company develops and manufactures assemblies that are used to process communication signals. These assemblies are integrated into both satellites and ground stations. For example, MIRAD is a supplier of specially dimensioned assemblies used by the European Space Agency (ESA) for communication and control of its interplanetary probes. The cubic components for these assemblies are now manufactured at MIRAD exclusively on FEHLMANN machining centers. With regard to contour accuracy and surface quality, the requirements for these assemblies are very high and increase proportionally with increasing frequency. In order to achieve comparably good transmission properties at 60 GHz as in the now globally established 30 GHz frequency band, a mechanical contour accuracy of one micrometer must be maintained. Initial trials were carried out on a FEHLMANN PICOMAX 56. This machine was specially equipped with a 4th axis for this purpose. Of particular interest was the repeatability of results in connection with the milling strategy and tool selection. After an intensive and relatively long test phase, Tony Blättler, Managing Director at MIRAD AG, was finally convinced that the investment in a VERSA 645 linear from Fehlmann

would make the advance into the nanometer range a realistic goal. Typically, MIRAD chooses exclusively 2.5 D contours for the realization of the functional components, which are milled from the solid at a fixed angle of attack. To minimize signal losses, the surfaces are subsequently silver-plated (layer thickness 15 to 20 micrometers) and milled to the defined target dimension in a subsequent process. This follow-up process, which usually takes place two to four weeks later, places high demands on both operators and infrastructure, since only a maximum of 5 micrometers of silver may be removed. The entire manufacturing process was developed and refined over several months... read more on our website www.fehlmann.com

Read the whole report and discover more interesting success stories on our website fehlmann.com/media

Simply hold your smartphone camera over the code.



Mirad manufactures various assemblies, and this requires not only precision, but also a certain universality in the processing machines.

(from left): Urs Schmid, CTO at Fehlmann AG, Tony Blättler, Managing Director at MIRAD and Adrian Tobler, Sales Manager Switzerland at Fehlmann AG.



Active for climate and environment

FEHLMANN Energy Task Force

Our company's own energy task force was established in the winter of 2022, with the aim of quickly and efficiently planning and implementing effective measures to optimize and reduce energy requirements.

The FEHLMANN energy team is comprised of employees from various departments and also involves our entire workforce. This guarantees that ideas and concrete measures can be bundled and implemented quickly and efficiently. Together, we motivate and sensitize all of our employees to use energy economically.

Environment and sustainability

It is with pleasure and pride that we successfully passed the re-certification in February 2022.

Our products and manufacturing processes are environmentally friendly, resource-saving and CE-compliant. We have always aligned our processes and structures to sustainable quality assurance; since 2007, FEHLMANN's quality and environmental management has been audited and certified according to the ISO 9001 standard and, since 2016, also to ISO 14001.

In order to actively and constantly optimize energy consumption and reduce CO₂ emissions, we have voluntarily participated in the program of the Energy Agency for Industry EnAW for many years. Efficient production processes, the high degree of in-house production, the



Since 2022, a new, compact and energy-efficient VERSA machining center has been in use in the FEHLMANN production facilities: the VERSA 945 with rack magazine RM 256 and automation solution Erowa Leonardo Multilevel. This enables various components to be manufactured with the highest precision, reliably and extremely economically. The production process is automated, lightly-manned and unmanned in two to three-shift operation.

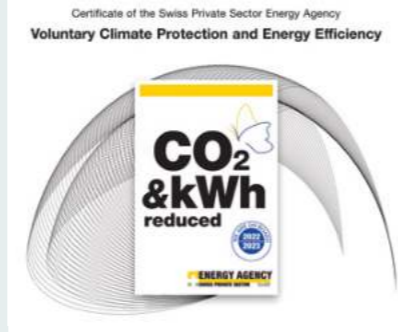

central production location, as well as the long service life of FEHLMANN machines, low energy consumption and many other aspects are key issues for sustainable environmental protection at our company.

Energy and resource-efficient production

Our path to climate-neutral production – European Green Deal

Our experienced team of designers and developers already uses the ISO 14955 standards, an effective tool with approaches to increase the energy and resource efficiency of machines, as a guideline during the conception of a FEHLMANN machine. The aim is to determine the main energy consumers, thereby allowing them to be optimized.

Energy consumption and efficiency of FEHLMANN machines are also tested and measured externally. The performance measurement of our machines is carried out in accordance with the ISO 14955-3 standard, which allows us to measure which components consume energy and at what level. This, in turn, is to implement targeted measures to avoid unnecessary energy use.



The new photovoltaic system will cover up to 1/3 of our electricity consumption as of late autumn 2023 – power (peak) 184 kW

Sustainability and energy efficiency from A-Z

When it comes to sustainability and (energy) efficiency, FEHLMANN does not focus only on projects pertaining to our machines. Rather, we examine processes and optimization potential from A to Z.

Thus, we rely on the consistent use of LED technology for lighting. Our training room was refurbished with modern technology such as touch-screen monitors for more practical orientation and efficiency during theoretical training. We now offer parking spaces with charging stations for e-mobility. From now on, customers and employees can charge their electric vehicles quickly and easily.

Photovoltaic system – investment in the future

From late fall 2023, solar modules will convert light into electrical energy on the roof of our plant. After the roof renovation, a photovoltaic system will be installed on a partial area, a further investment in sustainable, CO₂-free power supply. Thanks to the installed photovoltaic system, sustainable and energy-efficient heating of hot water in the painting department will be possible in the future. A combined heat pump boiler is used for this purpose. This means that hot water can

be provided almost autonomously, which is environmentally friendly and sustainable. In addition, the use of new, efficient cleaning agents that are already effective at lower water temperatures enables a further step away from fossil fuels.

Advanced energy saving functions

The effective energy consumption of a machine depends on the respective machining operation. However, not only the consumption at peak load, but also the permanent consumption during setup and changeover operations are taken into account in the development of FEHLMANN machining centers. In addition to various functions, such as automatic switch-off after execution of all programs, energy recovery and coolant pumps optimized for the operating point, we also offer an intelligent energy management system to significantly reduce power and air consumption: ECO-Mode. All unnecessary standby consumers are automatically switched off by means of a timer that is precisely adapted to requirements and switched on again in a matter of seconds, if necessary. Depending on the machine type and configuration, this can save up to 90% idle energy.

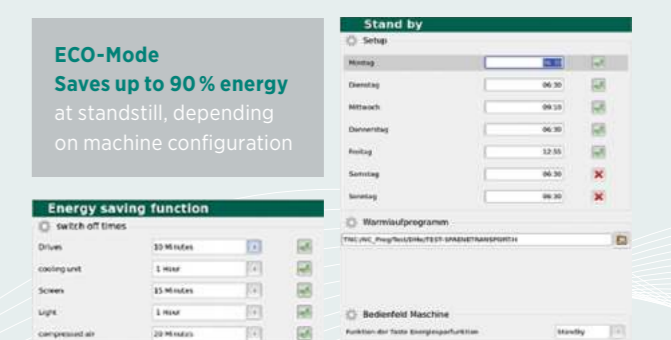
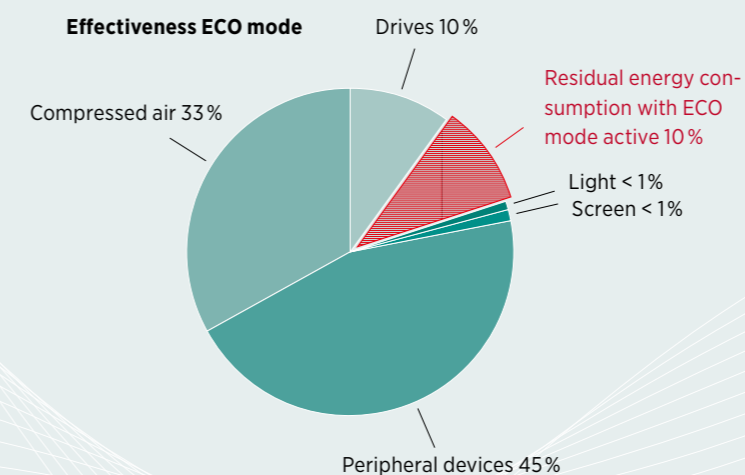

FEHLMANN introduces itself

“The difference is often beyond the visible.” And it is precisely this subtle difference that we bring closer to you in our image film. Take a quick look.



A strong team

It is with pleasure and pride that we were able to further expand our position as an important employer in the region, as well as at our service and sales subsidiaries in Germany and China. Thanks to newly created jobs, our workforce has grown to a size of around 200 employees worldwide.

Rooted in our business and production site in Seon, Switzerland, we are active throughout Switzerland and internationally. The high competence and flexibility of our employees are among our most important resources.

FEHLMANN – the 4th generation

New to the FEHLMANN team since 2022 is Dominik Fehlmann, the youngest son of Frank Fehlmann, CEO. Dominik Fehlmann works actively in the assembly and commissioning team. Welcome to the team.



The newly designed exhibition booth at the Swiss Production Forum 2022

FEHLMANN with a new look

Precise, accurate, flexible, dynamic, modern, innovative and familiar – these are the proven and well-known characteristics of the FEHLMANN brand. In communication, too, we live with our finger on the pulse of the market and have adapted our corporate design to the new needs and challenges of today's and tomorrow's modern and customer-oriented dialog.



FEHLMANN machines in action

With many machining examples, our product videos illustrate the highlights of FEHLMANN machines – simply, clearly and, of course, also efficiently.

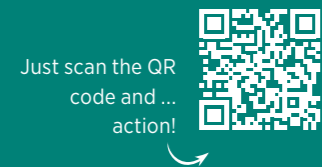

On a Friday evening in August, the smell of barbecue spread through the large shipping hall – the FEHLMANN team was spoiled with delicious specialties at the cookout.



Dominik Fehlmann is new in the assembly and commissioning team

“INNOVATE MANUFACTURING” – EMO HANNOVER 2023



After four years, EMO 2023 returns to Hanover. Visit us at booth C42 in hall 12 from September 18 – 23, 2023.

From the automated 5-axis high-performance machining center for production applications to the handy, conventional milling machine for individual parts and very small series – on exhibition space of 205 m² we will show the trade public a selection of five FEHLMANN machines for a wide range of applications.

More information and upcoming trade shows / events at www.fehlmann.com

Become a part of FEHLMANN

Do you also want to be part of our high-tech company? Click here for our job vacancies.



Simply hold your smartphone camera over the code.

Visit us also on social media



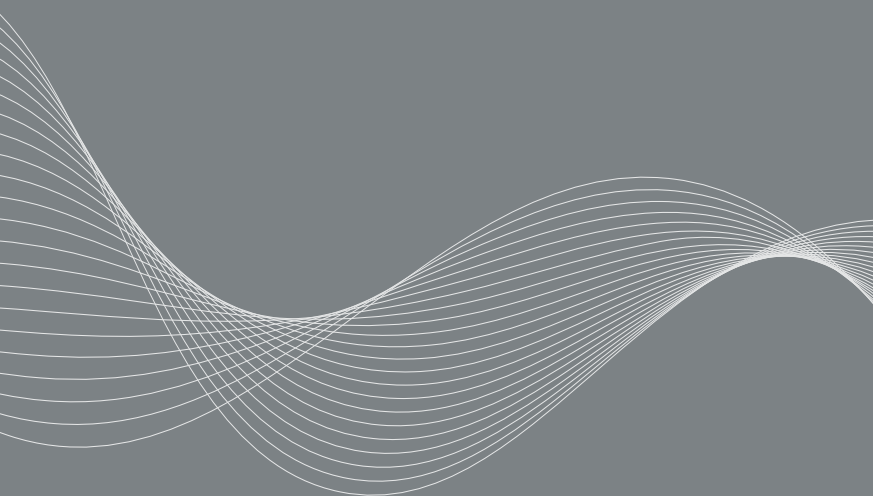

Machining centers in portal design



Machining centers



Milling/drilling machines



Service/Accessories



Automation

Fehlmann AG, leading-edge technology
"Made in Switzerland"

From development, design, manufacturing and
assembly to training and service.

With FEHLMANN you are one step ahead of your
competition.

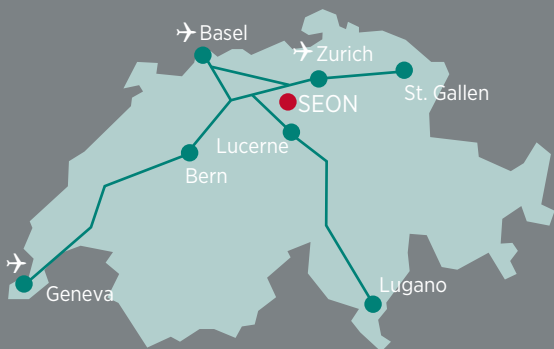

Fehlmann AG Maschinenfabrik
Birren 1 - 5703 Seon - Switzerland
Tel. +41 62 7691111
mail@fehlmann.com - fehlmann.com

Your Precision Advantage. 